



POLAR CASCADE™

Unit Specifications

COOLING TOWER

PC-085

SP-PC-085

Nominal tons are based on 95°F HW,
85°F CW, 78° Wet Bulb and 3GPM/Ton

Nominal Tons: 85

GPM:	255
Electrical:	208-230/460/3
Fans:	1 - 48"
Blades:	4
Motors:	1 - 3 hp
RPM:	1725
Full Load Amps:	208: 10.8 230: 8.4 460: 4.2
Cabinet:	16 GA. Galvannealed Steel
Base:	12 GA. Galvannealed Steel
Hot Water Basin:	16 GA. Stainless Steel
Finish:	3 mil. "Polane" Coating

Depth:	87.500"
Width:	72.200"
Height:	89.612"
Water Inlet:	6"
Water Outlet:	6"
Overflow:	2"
Make-up Water:	3/4"

Cold Water Basin Capacity:	63.64 gal.
Hot Water Basin Capacity:	66.83 gal.

Shipping Weight:	1,230 lbs.
Operating Weight:	4,447 lbs.

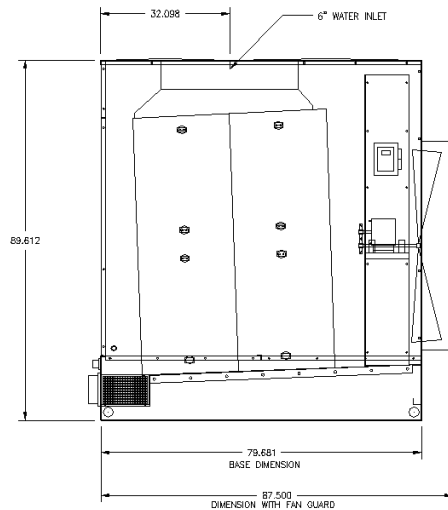
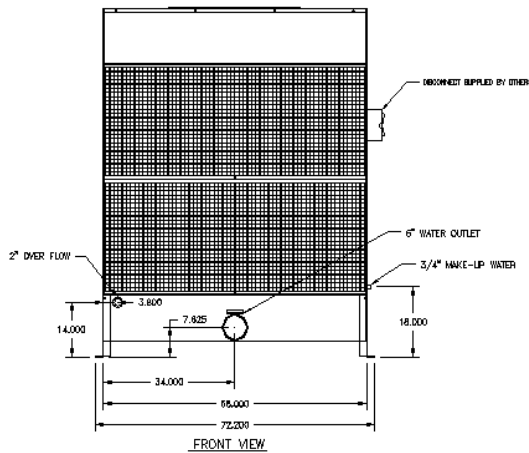

Available Accessories

- Water Storage Tank
- Intake Air Filter
- Basin Heater
- Heater Control Panel
- Vibration Isolators

*Cascade Cooling Towers are completely assembled. No field assembly required.
All units are run tested prior to shipment.*

Polar Air Systems, LLC

St. Louis, MO

www.polarairsystems.com

636-300-1589

© 2007 Polar Air Systems, LLC